

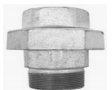











Wasserinstallation und Zubehör

Verschraubung		Verschraubung		Rohrnippel verzinkt		Winkel verz.		Winkel verz.	
1/2" verzinkt € 3,70	1/2" verzinkt € 4,60	1/2" 40mm € 1,10	1/2" 45 Grad € 3,40	3/4" 40mm € 1,20	1/2" 90 Grad € 1,90				
3/4" verzinkt € 4,20	3/4" verzinkt € 4,95	1/2" 60mm € 1,20		3/4" 60mm € 1,30					
									
Dichtung 1/2" € 0,60	Dichtung 1/2" € 0,60	1/2" 100mm € 1,30		3/4" 100mm € 1,80					
Dichtung 3/4" € 0,70	Dichtung 3/4" € 0,70	1/2" 150mm € 1,80		3/4" 150mm € 2,40					
2 x Innengewinde	Außen- u. Innengewinde	1/2" 200mm € 2,50		3/4" 200mm € 2,80					
		2 x Außengewinde		2 x Außengewinde			3/4" 45 Grad € 3,95		2 x Innengewinde oder Innen- und Außengewinde

Anschlüsse für IBC-Container		Muffe		Reduziermuffe		T-Stück		Hanfzopf	
	mit Panzerschlauch 70 cm Übergang 1/2" und 3/4"	1/2" € 1,30		3/4" - 1/2" € 2,80		1/2" verzinkt € 1,80		200 gr. € 3,20	
									
Wasserhahn 3/4" #221982 € 11,50	#221980 € 31,90	3/4" € 1,80		1" - 1/2" € 3,20		3/4" verzinkt € 2,50			
		2 x Innengewinde		2 x Innengewinde		3 x Innengewinde		Neo-Fermit	
								150 gr. € 8,20	

Kugelhahn mit Schlauchtülle		Muffen-Kugelhahn		Kugelhahn		Doppelnippel		Stopfen		Kappe	
		2 x Innengewinde		Innen- und Außengewinde		mit Sechskant		Außengewinde		Innengewinde	
		1/2" € 6,40				1/2" € 1,20					
1/2" € 7,90		3/4" € 8,90		1/2" € 7,20		3/4" € 1,60		1/2" € 1,10		1/2" € 1,40	
3/4" € 11,50		1" € 13,90		3/4" € 8,60							
1" € 15,90		1 1/4" € 24,90		1" € 13,50							
		1 1/2" € 32,50									
		2" € 46,50									

Schnellkupplung mit Schlauchanschluß		Gewindestück mit Innengewinde		Gewindestück mit Außengewinde		Dichtung		Blindkappe		Spritzdüse	
						lose		Verschuß			
											
1/2" € 2,80	1/2" € 2,60	1/2" € 2,60		€ 0,40		€ 2,80		1/2" € 7,80			
3/4" € 2,95	3/4" € 2,70	3/4" € 2,70						3/4" € 10,50			
1" € 3,80	1" € 2,90	1" € 2,90						1" € 14,90			
1 1/4" € 3,95	1 1/4" € 4,70	1 1/4" € 4,70									
1 1/2" € 5,40	1 1/2" € 4,95	1 1/2" € 4,70									

Kupplungen Stecksystem

	Stecker Messing	
	1/2" Außengewinde	2,90
	3/4" Innengewinde	2,90
	3/4" Außengewinde	2,90
	Kupplung Messing	
	1/2" Schlauch	4,90
	3/4" Schlauch	6,40
	Kupplung Messing mit Wasserstop	
	1/2" Schlauch	8,30
	3/4" Schlauch	8,50

Spritzdüse verstellbar 1/2" € 5,90

Schlauchschnellen



Schlauchschnellen V2A
Sortimentkasten 8-60 mm 50 Stück
€ 44,50

9 mm breit	verzinkt	V2A
8- 16 mm 3/8"	0,70	1,00
12- 20 mm 1/2"	0,70	1,00
16- 27 mm 3/4"	0,70	1,00
20- 32 mm 1"	0,70	1,10
12 mm breit		
verzinkt		
V2A		
25- 40 mm 1 1/4"	1,00	1,30
32- 50 mm	1,10	1,40
40- 60 mm	1,40	1,80
50- 70 mm	1,60	1,80
60- 80 mm	1,60	1,80
70- 90 mm	1,65	1,80
80-100 mm	1,80	1,90
100-120 mm	2,00	2,10

Wasserschlauch





Hochdruck-Qualitätsschlauch für Industrie, Gartenbau sehr flexibel kaltefest- alterungs- u. witterungsbeständig

Größe	Rollenslänge	Betriebsdruck	p/mtr. €	b. Rolle €
-15° bis +60°				
1/2" PVC gelb	50 Meter	15 bar	1,90	1,80
3/4" PVC gelb	50 Meter	15 bar	3,20	2,95
1" PVC gelb	50 Meter	12 bar	5,60	5,10
-40° bis +95°				
1/2" EPDM	40 Meter	20 bar	4,50	4,10
3/4" EPDM	40 Meter	20 bar	6,60	6,00
1" EPDM	40 Meter	20 bar	10,60	9,50
-40° bis +120°				
1/2" Premium	40 Meter	20 bar	9,80	grün



Kupplungen System Kamlock

aus Polypropylen	Vaterteil	€
	1 1/4" 32 mm	5,50
	1 1/2" 38 mm	5,50
	2" 51 mm	6,50
	Mutterteil	
	1 1/4" 32 mm	14,90
	1 1/2" 38 mm	16,90
	2" 51 mm	19,90

Kaltreiniger



für starke, hartnäckige und ölige Verschmutzungen

5 ltr. Kanister € 25,90

Waschgeräteschlauch pass. f. Kärcher

mit Gummiknickschutz

Länge	2-seitig M22 Überwurfmutter		mit Nippel 11 mm
	210 bar	400 bar	210 bar
10 mtr.	€ 86,50	€ 89,90	€ 79,50
15 mtr.	€ 115,00	€ 139,00	€ 109,00
20 mtr.	€ 119,00	€ 175,00	€ 159,00
Adapter mit Nippel 10 mm € 24,90			