

Siloentnahme / Zubehör für Dungstreuer und Ladewagen

Silosäcke 190 gr/m² grün
mit Griff und Verschußdraht



Größe	ab 50 St.	ab 100 St.
100 x 25 cm	€ 1,10	€ 0,90
120 x 27 cm	€ 1,20	€ 0,90

Drillapparat für Verschußdraht € 17,50

Siloschutzgitter 240 gr./m²
4 to Reißfestigkeit je m²



Größe	je Stück	ab 5 Stück
5 x 6 mtr.	€ 49,50	€ 46,90
5 x 7 mtr.	€ 57,50	€ 54,90
5 x 8 mtr.	€ 65,00	€ 62,90
5 x 9 mtr.	€ 73,50	€ 69,90
5 x 10 mtr.	€ 82,50	€ 78,90
5 x 12 mtr.	€ 99,00	€ 93,90
6 x 10 mtr.	€ 89,90	€ 85,90
10 x 12 mtr.	€ 198,00	€ 189,00

Messer für Siloblocksneider

passend für:
Fella Doppelmesser €
 860 lg. 418946 1 Satz 235,00
 1105 lg. 122192 1 Satz 459,00

Kuhn Doppelmesser €
 850 lg. 5048050 1 Satz 225,00
 1150 lg. 50481700 1 Satz 449,00

Strautmann €
 967/60/15 209,00
 860/9,5 Doppelmesser 1 Satz 215,00



Reparaturband für Silagefolie



75mm x 20 mtr.	schwarz	€ 11,90
100mm x 10 mtr.	schwarz	€ 3,90
100mm x 10 mtr.	grün	€ 3,90
100mm x 25 mtr.	weiß	€ 8,95

Silo-Entnahmezinken gekröpft



passend für:

	Länge	Kröpf.	€
Alö	18834	820/60/M24	€ 33,50
Alö	18921	920/60/M24	€ 38,00
Baas	18817	815/60/M20	€ 39,90
Bressel	18830	820/56/M22	€ 46,90
Fella	18920	920/43/M27	€ 53,50
Fella	18953	950/30/M22	€ 45,50
Fella	18958	950/43/M22	€ 53,50
Kverneland	18825	810/53/M20	€ 39,50
Kuhn	18852	880/40/M22	€ 44,50
Kuhn	181006	1000/40/M22	€ 48,00
Lengerich	18911	920/43/M22	€ 31,90
Stoll	18823	815/48/M20	€ 39,00
Stoll	18837	820/- /M28	€ 42,90
Stoll	18839	815/58/M24	€ 46,00
Strautmann	18814	800/60/M20	€ 38,00
Strautmann	M20	930/35 od. 60	€ 46,00
Strautmann	M20	1000/35 od. 60	€ 53,50
Strautmann	18843	840/45/M27	€ 42,50
Trioliet	18851	880/50/M22	€ 30,50
Vicon	18810	810/50/M22	€ 40,90
Vicon	18851	880/50/M22	€ 30,50
Weidemann	18828	810/40/M22	€ 40,50

Hochfeste Dungstreuerketten

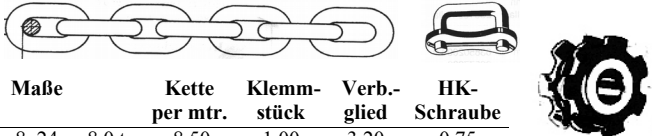

Maße	Kette per mtr.	Klemmstück	Verb.-glied	HK-Schraube
8x24	8,0 to 8,50	1,00	3,20	0,75
8x31	8,0 to 7,90	1,20	3,20	0,90
9x31	9,0 to 9,50	1,20	3,20	0,80
9,5x27	9,0 to 11,90	1,60	3,30	1,20
10x31	10,0 to 10,90	1,30	3,30	0,90
10x35	10,0 to 10,70	1,30	3,90	1,10
11x31	11,5 to 13,50	1,60	3,90	1,70
11x35	11,5 to 13,50	1,90	3,90	1,20
13x36	15,2 to 19,90		5,90	
14x50	17,8 to 29,50		18,50	

Kratzbodenleisten - Streuflügel

passend für

	Länge	Bohrung	€
Bergmann M-Profil	1640 mm	10,5 Ø	26,50
Kemper Spez.-Profil gerade	1560 mm	10,5 Ø	28,90
Kemper U-Profil 25x50 M	1780 mm	13,0 Ø	29,50
Krone M-Profil gewölbt	1450 mm	10,5 Ø	27,50
Krone M-Profil gewölbt	1650 mm	10,5 Ø	32,50
Mengele U-Profil 40x20 P	1600 mm	10,5 Ø	23,50
Mengele U-Profil 25x50 F	1720 mm	10,5 Ø	29,50
Strautmann U-Profil 30x60 F	775 mm	12,0 Ø	36,50
Tebbe mit Rübüg Glied HF78	733 mm		46,50
Welger Spez.-Profil gew.	1580 mm	10,5 Ø	29,50
Welger Spez.-Profil gew.	820 mm	12,0 Ø	22,90

Wurfschaufel Tebbe L/R 315 mm 25,90
 Streuflügel Bergmann 09570052/53 25,90

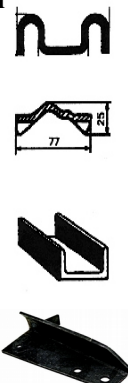

Einfach - Rollenketten



Tagex	Teilung mm	innere Breite	Rolle Ø mm	Preis per mtr.	Glied gerade	Glied gekröpft
1/2" x 3/16"	12,70	4,88	7,75	€ 8,50	€ 1,40	€ 3,80
1/2" x 1/4"	12,70	6,40	7,75	€ 8,70	€ 1,10	€ 2,00
1/2" x 5/16"	12,70	7,75	8,50	€ 8,90	€ 1,00	€ 1,50
5/8" x 3/8"	15,88	9,65	10,15	€ 9,40	€ 1,10	€ 1,70
5/8" x 3/8" V	15,88	9,65	10,15	€ 12,00	€ 1,50	€ 2,80
3/4" x 7/16"	19,05	11,70	12,07	€ 10,00	€ 1,20	€ 2,20
3/4" x 7/16" V	19,05	11,70	12,07	€ 17,50	€ 1,90	€ 3,00
3/4" x 1/2"	19,05	12,60	11,91	€ 12,50	€ 1,60	€ 2,70
3/4" x 1/2" V	19,05	12,60	11,91	€ 20,40	€ 1,90	€ 3,90
3/4" x 13,5mm	19,05	13,50	12,07	€ 18,00	€ 1,90	€ 2,90
1" x 1/2"	25,40	12,70	12,70	€ 54,90	€ 2,50	€ 4,50
1" x 1/2"	25,40	12,70	15,90	€ 49,50	€ 2,50	€ 4,60
1" x 5/8" ASA80	25,40	15,75	15,90	€ 39,50		
1" x 17mm/16B1	25,40	17,02	15,90	€ 19,50	€ 2,30	€ 3,40
1 1/4" x 3/4" 20B	31,75	19,60	19,05	€ 33,50	€ 3,50	€ 5,60
1 1/4" x 3/4" ASA100	31,75	19,60	19,05	€ 69,00	Laschen 4,9 mm	
1 1/2" x 1" 24B1	38,10	25,40	25,40	€ 59,00	€ 4,40	€ 8,50
1 1/2" x 1" ASA120	38,10	25,22	22,23	€ 119,00	Laschen 5,7 mm	



Duplex - Rollenketten

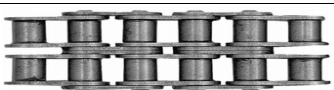

	Teilung mm	innere Breite	Rolle Ø	Preis per mtr.	Glied gerade	Glied gekröpft
3/4" x 1/2"	19,05	12,70	11,91	€ 35,50	€ 2,30	€ 5,40
1" x 17	25,40	17,02	15,90	€ 59,90	€ 5,90	€ 9,90

Stahlgelenkkette Org. Kohlsua

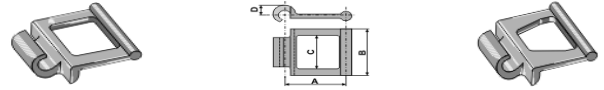





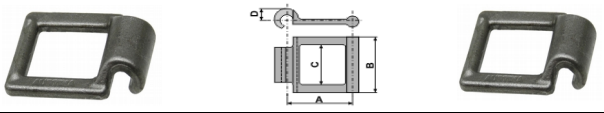

Art.Nr	Teilung A	Breite B	Bruchlast	Glieder p. mtr.	je Glied
69-074	60,6 mm	65,0 mm	65000 N	16,5	€ 4,10
69-078	67,1 mm	70,0 mm	50000 N	pass. f. JF / 14,9	€ 3,90
69-103	78,5 mm	87,0 mm	75000 N	12,7	€ 9,50







Original Rübüg Gliederkette gesenkgeschmiedet



Art.Nr	Teilung A	Breite B	Bruchlast	Glieder p. mtr.	je Glied
HF 59	59,0 mm	49,0 mm	60000 N	16,9	€ 5,90
HF 67	67,0 mm	62,0 mm	80000 N	pass. f. JF / 14,9	€ 9,50
HF 78	78,5 mm	82,0 mm	125000 N	12,7	€ 16,50

Wasserinstallation und Zubehör





Verschraubung		Verschraubung		Rohrnippel verzinkt		Winkel verz.		Winkel verz.	
1/2" verzinkt € 2,90	1/2" verzinkt € 3,80	1/2" 40mm € 0,80	1/2" 40mm € 0,90	1/2" 45 Grad € 1,90	1/2" 90 Grad € 0,90				
3/4" verzinkt € 3,70	3/4" verzinkt € 4,30	1/2" 60mm € 1,00	3/4" 60mm € 1,00						
									
Dichtung 1/2" € 0,60	Dichtung 1/2" € 0,60	1/2" 100mm € 1,20	3/4" 100mm € 1,30						
Dichtung 3/4" € 0,70	Dichtung 3/4" € 0,70	1/2" 150mm € 1,50	3/4" 150mm € 1,70						
2 x Innengewinde	Außen- u. Innengewinde	1/2" 200mm € 2,20	3/4" 200mm € 2,20			3/4" 45 Grad € 2,50	3/4" 90 Grad € 1,40		2 x Innengewinde oder
		2 x Außengewinde	2 x Außengewinde			2 x Innengewinde	Innen- und Außengewinde		

Anschlüsse für IBC-Container		Muffe	Reduziermuffe	T-Stück	Hanfzopf
	mit Panzerschlauch 70 cm Übergang 1/2" und 3/4"	1/2" € 0,90	3/4" - 1/2" € 1,40	1/2" verzinkt € 1,10	200 gr. € 2,95
Wasserhahn 3/4"					
#221982 € 12,90	#221980 € 37,90	3/4" € 1,20	1" - 3/4" € 1,60	3/4" verzinkt € 1,70	
		2 x Innengewinde	2 x Innengewinde	3 x Innengewinde	Neo-Fermit 150 gr. 4,95

Kugelhahn mit Schlauchtülle	Muffen-Kugelhahn 2 x Innengewinde	Kugelhahn Innen- und Außengewinde	Doppelnippel mit Sechskant 1/2" € 0,80	Stopfen Außengewinde 1/2" € 0,70	Kappe Innengewinde 1/2" € 0,90
					
1/2" € 5,90 3/4" € 8,50 1" € 12,50	1/2" € 4,95 3/4" € 6,90 1" € 10,90 1 1/4" € 19,50 1 1/2" € 26,50 2" € 38,00	1/2" € 5,25 3/4" € 6,95 1" € 11,90	3/4" € 1,10	3/4" € 0,80	3/4" € 1,20

Schnellkupplung mit Schlauchanschluß	Gewindestück mit Innengewinde	Gewindestück mit Außengewinde	Dichtung lose € 0,40	Blindkappe Verschuß € 2,80	Spritzdüse mit Schnellkupplung
					
1/2" € 2,50 3/4" € 2,70 1" € 2,90 1 1/4" € 3,95 1 1/2" € 5,20	1/2" € 2,50 3/4" € 2,50 1" € 2,50 1 1/4" € 4,70 1 1/2" € 4,70	1/2" € 2,50 3/4" € 2,50 1" € 2,50 1 1/4" € 4,70 1 1/2" € 4,70			1/2" € 7,80 3/4" € 10,50 1" € 12,90

Kupplungen Stecksystem

	Stecker Messing	€
	3/4" Innengewinde	2,70
	3/4" Außengewinde	2,70
	1" Innengewinde	2,70
	Kupplung Messing	
	1/2" Schlauch	5,30
	3/4" Schlauch	6,90
	Kupplung Messing mit Wasserstop	
	1/2" Schlauch	6,90
	3/4" Schlauch	6,50
	Spritzdüse verstellbar 1/2" € 5,90	

Schlauchschnellen

Schlauchschnellen V2A
Sortimentkasten 8-60 mm 18 Stück
€ 12,90



9 mm breit	verzinkt	V2A
8- 16 mm 3/8"	0,50	0,60
12- 20 mm 1/2"	0,50	0,70
16- 27 mm 3/4"	0,50	0,80
20- 32 mm 1"	0,60	0,80
12 mm breit	verzinkt	V2A
25- 40 mm 1 1/4"	0,80	1,00
32- 50 mm	0,90	1,10
40- 60 mm	0,90	1,20
50- 70 mm	1,10	1,20
60- 80 mm	1,20	1,35
70- 90 mm	1,30	1,45
80-100 mm	1,40	1,50
100-120 mm	1,60	1,70

Wasserschlauch

Hochdruck-Qualitätsschlauch für Industrie, Gartenbau
sehr flexibel kaltefest- alterungs- u. witterungsbeständig

Größe	Rollenlänge	Betriebsdruck	p/mtr. €	b. Rolle €
1/2" PVC gelb	50 Meter	15 bar	1,40	1,30
3/4" PVC gelb	50 Meter	15 bar	2,40	2,20
1" PVC gelb	50 Meter	12 bar	3,60	3,40
1/2" EPDM	40 Meter	20 bar	3,50	3,20
3/4" EPDM	40 Meter	20 bar	4,90	4,40
1" EPDM	40 Meter	20 bar	7,50	6,90
1/2" Premium	40 Meter	20 bar	6,90	grün
3/4" Premium	40 Meter	20 bar	10,80	grün
1" Premium	40 Meter	20 bar	13,80	grün

Kupplungen System Kamlock

aus Polypropylen	Vaterteil	€
	1 1/4" 32 mm	3,90
	1 1/2" 38 mm	3,90
	2" 51 mm	4,90
	Mutterteil	€
	1 1/4" 32 mm	12,90
	1 1/2" 38 mm	13,90
	2" 51 mm	14,90

Kaltreiniger

für starke, hartnäckige und ölige Verschmutzungen

5 ltr. Kanister **€ 19,95**

Waschgeräteschlauch pass. f. Kärcher

mit Gummiknickschutz

Länge	2-seitig M22 Überwurfmutter 210 bar	400 bar	mit Nippel 11 mm 210 bar
10 mtr.	€ 64,90	€ 89,90	€ 62,50
15 mtr.	€ 89,00	€ 129,00	€ 93,50
20 mtr.	€ 99,50	€ 145,00	€ 114,00
Adapter mit Nippel 10 mm € 19,90			